

SCD Series

Light weight warning light and electric horn combinations with polycarbonate housing for vessels and heavy industry applications



PRODUCT SPECIFICATION

SCDF | SCDW

Materials Lens-PC, Housing-PC+GF, Protection cage-ST5316L

Reflector-PC, Reflector-Heat resistant ABS

Ambient operating temperature

-20°C to +50°C: SCDFLR, SCDWLR, SCDF, SCDW

-30°C to +50°C: SCDFL, SCDWL, SCDFS, SCDWS

Protection rating IP66

Cable entry 1/2" PF

- Warning light and electric horn combinations for vessels and heavy industrial applications
- Light weight model with special polycarbonate (PC+GF) housing
- Excellent hermetic structure that blocks water and dust
- Superior impact and shock resistance
- Prevents damage from external contact with recessed horn structure, high volume output possible with the extended length of the horn housing
- Easy wiring and sound control with the terminal box attached on the side of housing
- Standard model comes with a protection cage equipped
- Can select a variety of light sources and sound pattern combinations
- Detachable mounting bracket structure enables product to be either self stand type or wall mount type
- Can adjust sound volume and select sound pattern with the switches built inside the units

audible sound since the sound control board is located separately from the main board

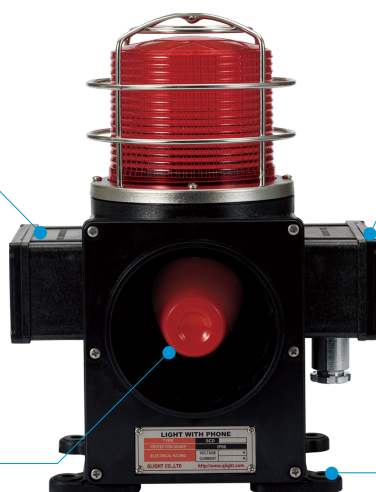









Easy wire configuration possible with terminal box located on the side of the housing

Recessed horn structure protects it from damage by external forces

Detachable mounting bracket structure enables product to be either self stand type or wall mount type

SCD Series Product Category Chart

	LED Revolving type	LED Steady/Flashing type	Xenon Strobe type	Bulb Revolving type
Self mount	 SCDFLR	 SCDFL	 SCDFS	 SCDF
Wall mount	 SCDWLR	 SCDWL	 SCDWS	 SCDW

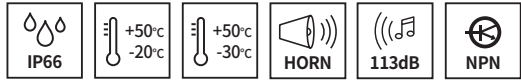

SCDF Series
Self mount



SCDW Series
Wall mount

SCDF / SCDW series are equipped with flexible connector at cable entry. Cable gland is an optional item.

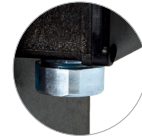

Flexible connector

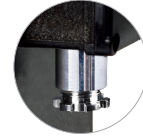

Cable gland

SCDFLR / SCDWLR LED Revolving Warning Light & Electric Horn Combination

Model number	Voltage	Current	Sound Pattern and Volume	Certificates	Weight	Color
SCDFLR SCDWLR	DC12V	2.633A	· WS-5 Warning sounds: Max.113dB · WP-5 Special warning sounds: Max.113dB · WM-5 Melodies: Max.113dB · WA-5 Alarms: Max.113dB · WV-5 Customizable voices: 108-113dB	CCS	2.70kg	● R-Red
	DC24V	1.288A				● A-Amber
	AC110V	0.308A			● G-Green	
	AC220V	0.154A			● B-Blue	

- Excellent omni-directional visibility with LED light collecting system and special multifaceted reflector
- Revolving speed: 120-140RPM
- Ambient operating temperature: -20°C to +50°C

SCDFL / SCDWL LED Steady/Flashing Warning Light & Electric Horn Combination

Model number	Voltage	Current	Sound Pattern and Volume	Certificates	Weight	Color
SCDFL SCDWL	DC12V	2.511A	· WS-5 Warning sounds: Max.113dB · WP-5 Special warning sounds: Max.113dB · WM-5 Melodies: Max.113dB · WA-5 Alarms: Max.113dB · WV-5 Customizable voices: 108-113dB	CCS	2.52kg	● R-Red
	DC24V	1.222A				● A-Amber
	AC110V	0.286A			● G-Green	
	AC220V	0.143A			● B-Blue	

- Multi layer LED reflect system emits clear and uniform level of signal lights throughout the lens
- Flashing rate: 60-80 flashes/min(Built-in steady/flashing selection switch)
- Ambient operating temperature: -30°C to +50°C

SCDFS / SCDWS Xenon Lamp Strobe Warning Light and Electric Horn Combination

Model number	Voltage	Current	Bulb			Sound Pattern and Volume	Certificates	Weight	Color
			Spec	Standard	Parts no				
SCDFS SCDWS	DC12V	2.933A	200V	EUB0641	48	· WS-5 Warning sounds: Max.113dB · WP-5 Special warning sounds: Max.113dB · WM-5 Melodies: Max.113dB · WA-5 Alarms: Max.113dB · WV-5 Customizable voices: 108-113dB	CCS	2.46kg	● R-Red
	DC24V	1.411A							-1A(G)
	AC110V	0.360A						U type	● G-Green
	AC220V	0.220A							● B-Blue

- Convenient lamp exchange by adopting connector type lamp installation
- Flashing rate : 60-80 flashes/min
- Ambient operating temperature : -30°C to +50°C

SCDF / SCDW Bulb Revolving Warning Light and Electric Horn Combination

Model number	Voltage	Current	Bulb			Sound Pattern and Volume	Certificates	Weight	Color		
			Spec	Standard	Parts no						
SCDF SCDW	DC12V	3.755A	12V15W	G23 15S	17	· WS-5 Warning sounds: Max.113dB · WP-5 Special warning sounds: Max.113dB · WM-5 Melodies: Max.113dB · WA-5 Alarms: Max.113dB · WV-5 Customizable voices: 108-113dB	CCS	2.68kg	● R-Red		
	DC24V	1.788A							24V15W	G23 15S	18
	AC110V	0.422A						12V15W	G23 15S	17	● G-Green
	AC220V	0.211A									G23 15S

- Multi layer reflector system provides excellent signal light diffusing effect
- Revolving speed : 120-140RPM
- Ambient operating temperature : -20°C to +50°C

※ CE compliant : DC24V

※ Max. built-in volume feature is based on WS/WP-Ch1/WM-Ch5/WA-Ch4.

※ In case of customized WV 5 tone type, there may be difference of volume depending on user's audio file type.

SCD Series

Technical Diagram ·SCDFLR / SCDFL / SCDFS / SCDF

Units: mm

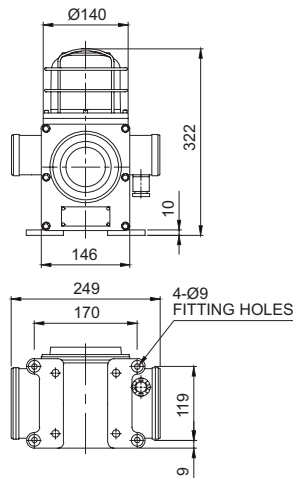

·SCDWLR / SCDWL / SCDWS / SCDW

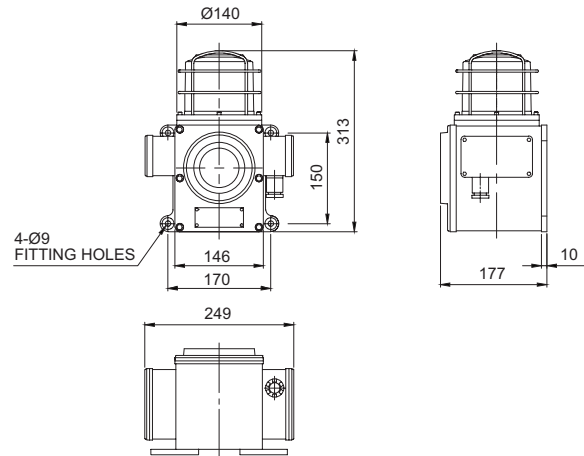

Sound Selection Instructions and Wiring

- SCDW Series-DC/AC
- SCDF Series-DC/AC

· Customization: External contact(LC)

· Standard Type: Select sound using the switch inside of the unit. When you turn on the dip switch for each channel, the designated sound will be played.

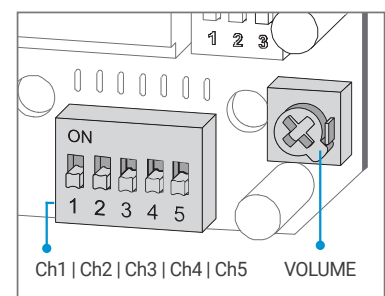
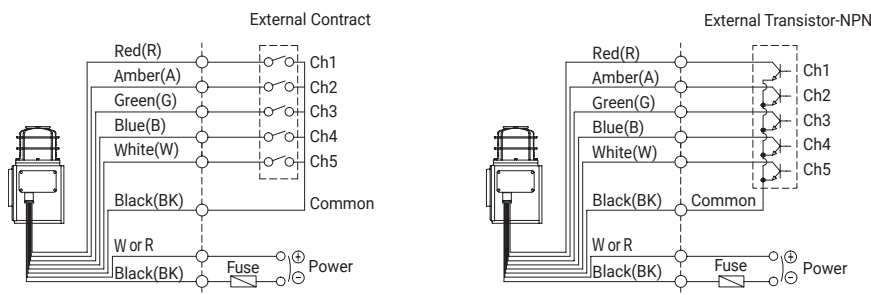

Wiring Instructions

· SCDF, SCDFLR, SCDW, SCDWLR - Black output line is negative(-).

Sound tones for standard model

- Customized cable entry(3/4"PF) available(Standard : 1/2"PF)
- Customized external sound line type available : SCD series has built-in switch for sound tone selection
- Customized wiring available to select the sound tone via external contact or transistor wiring type(Model number : -LC)
- Cable gland type

Ordering Specification

SCDW	-	WA	-	24	-	R	-	LC
[Model number]		[Sound]		[Voltage]		[Color]		[Sound selection]
SCDFLR SCDFL SCDFS SCDF SCDWLR SCDWL SCDWS SCDW		WS-Warning sounds WP-Special warning sounds WM-Melodies WA-Alarms WV-Customizable voices		12-DC12V 24-DC24V 110-AC110V 220-AC220V		● R-Red ● A-Amber ● G-Green ● B-Blue		(blank)-Built-in switch LC-External contact