

After reading this guide, keep it handy for future reference.



User's Guide

Hitachi Inverter

Feedback Option

P1-FB

Fundamental

Verification

S Introduction

C Contents

1 Safety Precautions

2 Overview

3 Preparing for Operation

4 About the P1-FB

5 Bundled Items

6 Installing and Connecting

7 FAQ and Troubleshooting

8 Specifications

When contacting us, please let us know the following reference number.

NT253X

S.1 Introduction

Thank you for purchasing the Hitachi SJ series P1 (SJ-P1) Feedback Option (P1-FB)

This user's guide describes how to handle and maintain the "P1-FB". Please read this guide carefully before using the P1-FB, and keep it handy for those who operate, maintain and inspect it.

■About the User's Guide(this document)

The User's Guide provides detailed information necessary for handling the product. Please make sure to read this Guide for proper use.

Always use the P1-FB strictly within the range described in the User's Guide and perform proper inspection and maintenance to prevent failures or accidents.

The latest version of the User's Guide can be obtained through our website. In case it is not available or cannot be downloaded, please contact the nearest sales office.

■Handling the inverter

For handling the inverter, please make sure to read its Basic Guide and User's Guide.

S.2 Cautions

■For a proper use

Before using the inverter, please read carefully the inverter's Basic Guide, User's Guide and this guide. In Addition any personnel handling or performing maintenance of the product must read carefully the inverter's Basic Guide, User's Guide and this guide.

Before any attempt to install, operate, maintain or inspect this equipment, a complete understanding of the equipment specifications, safety instructions, precautions, handling and operation instructions is required. Please follow all the specifications and instructions for a proper use.

Additionally, periodically review the inverter's Basic Guide, User's Guide and this guide.

■Precautions

It is prohibited to reproduce or reform this document partially or totally in any form without the publisher's permission.

The contents of the document are subject to change without prior notice.

If a hard copy of this document is required please contact the sales office on the back cover. Keep in mind that you will be charged for a hard copy of this document.

Any handling, maintenance or operation method NOT described on the inverter's Basic Guide, User's Guide or this guide is not covered by the product warranty. Please DO NOT perform any procedure NOT described on the SJ-P1 and the P1-FB guides since it can be the cause of unexpected failures or accidents.

We are not responsible for any impact from operations regardless of unexpected failure or accident due to operation or handling of the product in a manner not specified on the inverter's Basic Guide, User's Guide and this guide. We appreciate your understanding.

If you find any unclear or incorrect description, missing description or misplaced or missing pages, Please inform the Hitachi inverter technical service office.

Note that, in case the inverter's Basic Guide, User's Guide and this guide are enclosed, they should be delivered to the end user of the inverter. Also make sure to download and keep accessible any other related guides or instructions for the end user.

S.3 Product Warranty and Inquiry

■ About Product Inquiry

- For an inquiry about product damage or faults or a question about the product, notify your supplier or Hitachi inverter technical service office.

When contacting the technical service, please provide the following information

- Model: P1-FB
- Manufacture Number (MFG No.) :It shows on the name plate. (Please refer to the chapter 4, for more information)
- Date of Purchase: Purchase date by the customer
- Inquiry contents
 - Inform us the defective point and its condition.
 - Inform us the suspicious content and its details.

■ Product Warranty

- The product P1-FB will be warranted by Hitachi Industrial Equipment Systems Co., Ltd.(afterwards referred as "Hitachi") during the warranty period from your date of purchase only under proper usage of product.
- However, the warranty expressed here is covered only for products delivered from Hitachi, and will not be responsible for others damage or loss of products like a motor or any equipment or systems damage caused by improper usage of the product. We recommend applying safety design which is able to provide a hazard notice to the user in case of malfunction or damage of the delivered product to minimize the consequences on other equipment or system. We advise that the selection of the delivered product is done with sufficient margin for performance, as well as using redundant design for other equipment or systems. Also, the compatibility of the product with the customer's intended use is not warranted, hence the customer has the responsibility to perform validation tests before any operation.
- In case a defective product is delivered, or quality failure during the manufacturing process are detected, Hitachi will repair or exchange the product free of charge, only during the product warranty period (afterward, we call "warranty service")
- The product will be warranted for one year from the date of purchase. However, depending on the case, actual expenses for sending technical assistance will be charged to the customer. Also, Hitachi will not be responsible of any readjustment or testing on site.
- After a warranty service, the exchanged or repaired part will be warranted for 6 months from the date of the warranty service. Hitachi will be responsible for repairing or exchanging the previously exchanged or repaired part only during this warranty period

- Please verify that the inverter settings are adequate for operation, before operating it remotely through the network.

- In order to receive warranty service, you should present the receipt issued by the product supplier or any other document that allow us to check the purchase date. However, any defects, damage, malfunction or any other failure caused by one of the following facts will not be covered by warranty service.

- (1) Cannot confirm the purchase date.
- (2) The damage or fault resulted from improper usage or inadequate handling of the product or usage that does not comply with the instructions described in the user's guide or basic guide.
- (3) Incorrect usage of the product and/or the inverter, inadequate setting of the product and/or the inverter, remodeling or inadequate repair or repair carried out by an unqualified repair center.
- (4) Deterioration and wear as result of normal operation.
- (5) Fault resulted from natural disaster, such as earthquake, fire disaster, lightning strike, pollution, salt pollution, or abnormal voltage or any others external factors.
- (6) Shock, falling, or Vibration resulted during transportation or displacement after purchase.
- (7) Damage or fault resulted from remodeling firmware by unqualified personal not belonging to Hitachi.
- (8) Damage or fault resulted from using a function program (EzSQ).
- (9) For overseas use.

- Data stored inside the product, as well as the customers made (EzSQ)program might get lost during a warranty service. It is the customer responsibility to make a backup of the data. However, in case of a malfunction resulting from the circuit board of the storage devices, the backup will not be possible. It is recommended to make a backup during the testing phase by using the VOP or the PC software ProDriveNext.

■ Liability Limitation

- In this product warranty, all warranties offered to the customer are stipulated, and neither Hitachi, affiliated companies or related dealers are liable to any express warranties or implied warranties including, but not limited to, product merchantability or specific application fitness.
- Also, Hitachi, affiliated companies or related dealers are not responsible of any incidental damage, special damage, direct loss, or indirect loss (even predictable or not) sustained by the customer as a result of a faulty product.

■ Using the Warranty Service

- The customer is able to receive a warranty service during the warranty period from the product supplier or service station, if the product does not meet the specifications described in this guide. However, this guide will have priority in case of content mismatch between this and the basic guide.
- A fare-paying service can also be obtained by contacting your supplier, local Hitachi distributor or service station.

■ Change on Product Specifications

- Please be aware that the information described in Brochure, Basic Guide, User's Guide or Technical Document might be modified without notice.

■ Precautions for Product Operation

- The product should be operated following the working conditions, handling methods and precautions described in User's Guide.
- Please verify that the inverter settings are adequate for operation, before operating it remotely through the network.
- Please verify that the Hitachi inverter is correctly configured and installed for the intended purpose in the designed system.
- When using the Hitachi inverter please implement the following actions.
 - (1) Select an inverter with sufficient capacity for the rated current and performance
 - (2) Implement safety design such as redundant system design
 - (3) Implement safety design which minimizes risks in case of an inverter failure.
 - (4) Design the system in a way it can warn the operator about any danger.
 - (5) Carry out periodic maintenance to the customer's equipment as well as the inverter.
- For applications that involve human life, or have risk of an important loss, make sure to avoid a critical accident by installing a fail-safe device, protecting device, detecting device, alarm device, and/or spare device, etc.

■ Supplement

- This warranty term will not restrict the legal right of customer who has purchased the product.
- This warranty is valid only in Japan(excluding special types of contracts)
- Contact your sales agent for warranty of products purchased overseas.

S.4 Procedure before a Trial Run

- Please follow the steps written below for start using the P1-FB
- Before operating the device, please read and fully understand the safety precautions written below and on the Chapter 1.

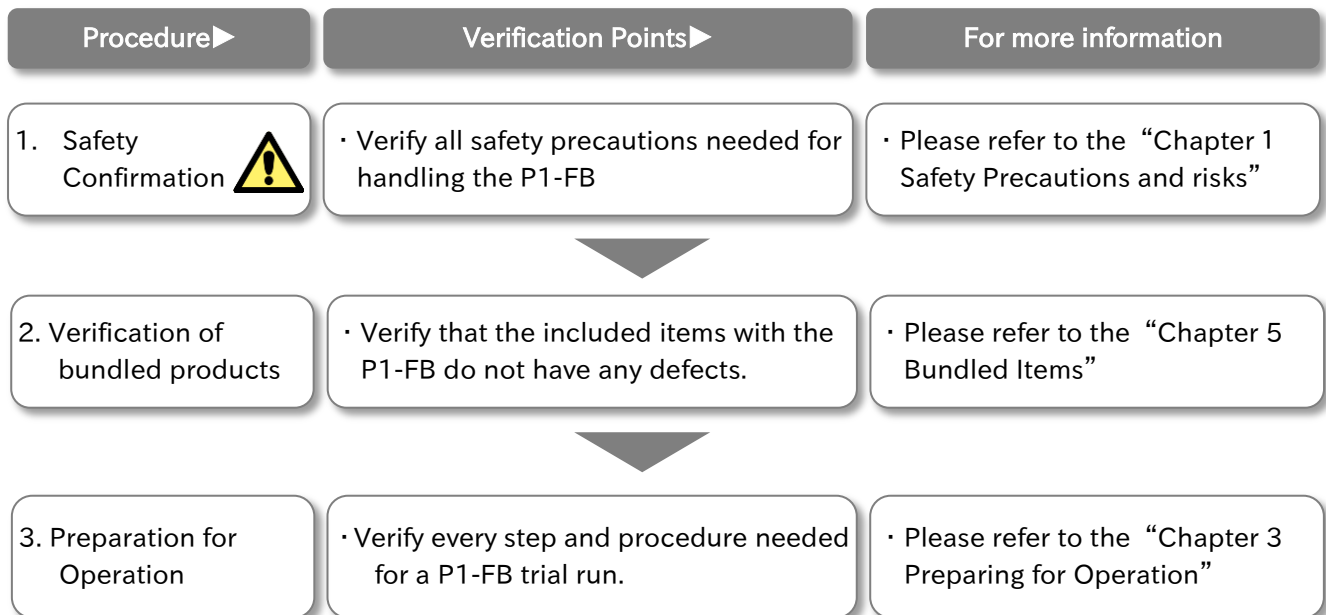

For more information, please refer to the inverter's Basic Guide and User's guide.

S.5 Related Manuals

Document Name	Document Code
P1-FB (Feedback option) User's Guide (this manual)	NT253X

Document Name (Inverter)	Document Code
SJ series P1 User's Guide	NT251*1) X
SJ series P1 Basic Guide	NT2511*1) X

“*1)” represents the edition code.

C.1 Table of Contents

● Introduction · Caution.....	S-1	● Table of Contents.....	C-1
● Product Warranty and Inquiry.....	S-2		

Chapter 1 Safety Precautions

1.1 About this chapter.....	1-1	1.4 Precautions	1-3
1.2 Types of warnings.....	1-1	1.5 Caution label examples.....	1-7
1.3 Symbol explanation.....	1-2		

Chapter 2 Overview

2.1 About this chapter.....	2-1	2.4 Guide objectives.....	2-1
2.2 Applicable devices	2-1	2.5 Guide outline	2-1
2.3 Before reading this guide	2-1		

Chapter 3 Preparing for Operation

3.1 About this chapter.....	3-1	3.2 Preparation steps	3-1
-----------------------------	-----	-----------------------------	-----

Chapter 4 About the P1-FB

4.1 About this chapter.....	4-1	4.4 Wire disconnection detection.....	4-3
4.2 P1-FB overview and the precautions	4-1	4.5 Name plate.....	4-3
4.3 Appearance and each part name of the product.....	4-2	4.6 Dimensions after installation.....	4-3

Chapter 5 Bundled Items

5.1 About this chapter.....	5-1	5.3 Verification after the purchase.....	5-2
5.2 About the bundled items.....	5-1		

Chapter 6 Installing and Connecting

6.1 About this chapter.....	6-1	6.3 Installation.....	6-2
6.2 Supported inverters	6-2	6.4 About the wiring and connection	6-4

Chapter 7 Inverter Setting

7.1 About this chapter.....	7-1	7.3 P1-FB troubleshooting	7-3
7.2 Self-diagnosis.....	7-2		

Chapter 8 Specifications

8.1 About this chapter.....	8-1	8.2 Product specifications.....	8-1
-----------------------------	-----	---------------------------------	-----

1

Chapter 1 Safety Precautions

Contents

1.1 About this chapter.....	1-1
1.2 Types of warnings.....	1-1
1.3 Symbol explanation.....	1-2
1.4 Precautions	1-3
1.4.1 Please be careful!	1-3
1.4.2 Precautions during the installation!	1-3
1.4.3 Precautions during the wiring!.....	1-4
1.4.4 Precautions during operation!	1-5
1.4.5 Precautions during maintenance/ inspection!	1-5
1.4.6 Precautions for disposal !	1-6
1.4.7 Other precautions.....	1-6
1.5 Caution labels examples	1-7

1.1 About this chapter

This chapter contains the information about Safety precautions during the installation, wiring, operation and inspection.

Before installation, wiring, operation, inspection, or usage please read completely and fully understand this guide.

1.2 Types of warnings

In this guide, the safety precautions as well as potential risks are categorized by degree of risk as “Danger” , “Warning” and “Caution”

The definition of each category is described below

Danger

This category warns the user that in case of an incorrect or improper handling, it leads to a dangerous situation that have a high risk of causing death, serious injuries and/or major property damage

Warning

This category warns the user that in case of an incorrect or improper handling, it leads to a dangerous situation that may cause death, serious injuries and/or major property damage

Caution

This category warns the user that in case of an incorrect or improper handling, it leads to a dangerous situation that may cause physical injuries and/or property damage.







However, any content labeled with “ **Caution**” and depending on the case, might have a possibility of leading to a highly dangerous situation. It is extremely important that you follow the instructions and warnings

Furthermore, content labeled with “” must be followed and paid special attention .

1.3 Symbol explanation

In this document, there are some explanatory notes using different symbols. Please pay attention to this content and keep in mind its information.

Symbol definition

	<p>When handling this product, this symbol indicates danger, warning, caution about ignition, electric shock, high temperature and others.</p> <p>Inside or near the  symbol, the specific content will be shown.</p>
	<p>This symbol indicates “General hazard not specified, be cautious”</p>
	<p>This symbol indicates “Electric shock hazard”</p>
	<p>This symbol indicates prohibited actions “Actions that should not be done” when handling this device.</p>
	<p>This symbol indicates actions that must be done based on the instructions.</p>

1.4 Precautions

1.4.1 Please be careful!

Danger



Caution

· If handled incorrectly or improperly, it might cause death, serious physical injuries, or damage to the inverter, motor or even the entire system.



Do

· Before installation, wiring, operation, inspection, or usage please read and fully understand this guide.



Caution

· In order to explain this device details the illustrations in this guide might show this device without covers.



Do

· Before operating this device please return all the covers to the original position, and follow all the necessary regulations and instructions written in this guide



Caution

· There will be additional warnings about hazards and failure causes in other chapters.



Do

· Before installation, wiring, operation, inspection, or usage please read and fully understand this guide.

1.4.2 Precautions during the installation!

Warning



Fire Hazard

● Risk of Fire !

· DO NOT place inflammable objects nearby

· DO NOT let scraps of wire, welding sputtering, irons scraps or other objects get inside the device



Prohibited



Do

· Avoid installing this device in places with high temperature, high humidity, Condensation-prone conditions, dusty conditions, corrosive gas, explosive gas, flammable gas, grinding fluid mist, hydrogen sulfide or salt damage prone conditions. Additionally, it is recommended to install this device in ventilated room not exposed to direct sunlight.



Failure

● Risk of an Inverter failure !

· This device is a precision equipment, do not drop it, or give it a strong shock.

· DO NOT get on (step on) or place heavy objects on this device.

· When handling the object, avoid places prone to static electricity(like carpets).



Prohibited



Do

· Since the human body can get charged with static electricity, as a safety measure please touch a safe metallic surface before handling this device



Injury

● Risk of Injury !

· DO NOT install or operate products with damage or missing parts.



Prohibited

1.4.3 Precautions during the wiring!

**Danger**

Electric shock and Fire hazard

- **Risk of an electric shock and/or fire !**
- Be sure to ground the inverter.
- Entrust the wiring work only to a qualified electrician
- Before the wiring work make sure to turn off the power supply and wait for 10 minutes or more. (Confirm that the charge lamp is OFF and the DC voltage between terminals P and N is 45 V or less)



Do



Electric shock and injury

- **Risk of an electric shock and/or injury !**

- Perform the wiring only after installing the inverter



Do



Failure

- **Risk of inverter failure !**



Prohibited

- DO NOT pull any wire after wiring



Do

- Be sure to operate the switch of P1-FB after power off.
- Be sure to fix on the wiring, and avoid extra burden to the connector.

**Warning**

Electric shock and injury

- **Risk of an electric shock and/or injury !**

- Be sure to operate the switch of P1-FB after power off.
- Please handle the cables properly and do not let them get damaged.
- Be sure to fix on the wiring, and avoid extra burden to the connector.



Do



Fire hazard

- **Risk of Fire !**

- Please tighten the screws and bolts with the specified torque.(Please refer to the inverter user's guide)
- Verify that none of the screws and bolts are loose.
- Make sure that the inverter and this device are fixed together with the securing screw.
- Make sure that the connectors are properly fixed.



Do

1.4.4 Precautions during operation!

 **Danger**● **Risk of an electric shock or fire !**

Electric shock and Fire hazard

- DO NOT touch the inside of this device, check the signal, do any wiring or plug/unplug the connectors while it energized.
- DO NOT touch the inside of this device or the inverter while they are energized



Prohibited

● **Risk of an injury and/or fire !**

Injury and Fire hazard

- DO NOT touch the inside of this device or the inverter while they are energized



Prohibited



Electric shock

● **Risk of an electric shock !**

- Make sure to fasten all the screws of this device before turning it on. DO NOT detach this device while it is energized or the inverter capacitors are still charged. Additionally DO NOT touch the inverter while the inverter capacitors are still charged.
- DO NOT touch this device with wet hands.



Prohibited

 **Warning**● **Risk of an injury and/or device damage !**

Injury or device Damage

- By using this device it becomes easier to change the settings and the output frequency of the inverter. When changing the settings or the output frequency of the inverter please make sure that it is within the supported range by the motor and/or the equipment.



Do

- In case this device is being used to make the inverter produce high frequency outputs for a motor or other equipment, make sure with the respective manufacturer that the motor or the equipment can tolerate the high frequency output given by the inverter.
- During operation verify the motor rotation direction, and that there are no irregular sounds or vibrations

1.4.5 Precautions during maintenance/ inspection!

 **Danger**

Electric shock

● **Risk of an electric shock !**

- Before any maintenance or inspection make sure to turn off the power supply and wait for 10 minutes or more. (Confirm that the charge lamp is OFF and the DC voltage between terminals P and N is 45V or less)



Do



Prohibited

- Entrust the maintenance, inspection and/or part replacement only to a specialized personnel. (Be sure to remove wristwatches and metal accessories, e.g., bracelets, before maintenance and inspection work and use insulated tools for the work.)

1.4.6 Precautions for disposal !

**Danger**

 Injury and explosion hazard	<ul style="list-style-type: none"> ● Risk of an injury and/or an explosion ! <p>Outsource to a qualified industrial waste disposal contractor when discarding this device. Disposing of this device on your own may result in the production of poisonous gas</p> <ul style="list-style-type: none"> · Contact Hitachi technical service or your sales agent if you need to get this device fixed 	 Do	<ul style="list-style-type: none"> · A qualified waste-disposal service vendor means industrial waste collector/transporter and industrial waste disposal operator. Follow all laws and decrees related to procedures of waste management and public cleansing when disposing of this device.
---------------------------------	---	--------	--

1.4.7 Other precautions

**Danger**

 Electric shock injury and Fire hazard	<ul style="list-style-type: none"> ● Risk of an injury, an electric shock and/or fire !
 Prohibited	<ul style="list-style-type: none"> · DO NOT modify this device

※In addition to the precautions described above, there are other precautions described in the chapter 8 of the inverter user's guide. Please read and follow those precautions as well.

1.5 Caution labels examples

- We include the caution label templates so motor, inverter or system related accidents or dangerous situations may be prevented. Please use these labels for your system or equipment.
- When the inverter is configured for remote operation, automatic operation or the retry function is active, there are cases when the operation will be resumed automatically after a shut down. In order to warn about this cases please use the label example on the right side as a reference.

(Label Template)

- Please fill in the label and use it for preventing accidents.

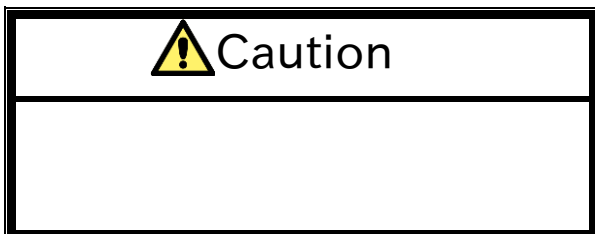

(Label example)

- For warning about automatically resumed operation after an error as a result of the retry function.

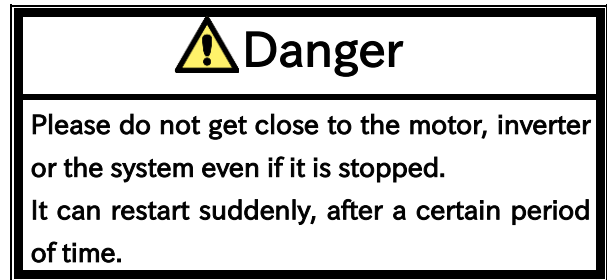

(Label example)

- For warning about remote or automatic operation after the system is powered on.

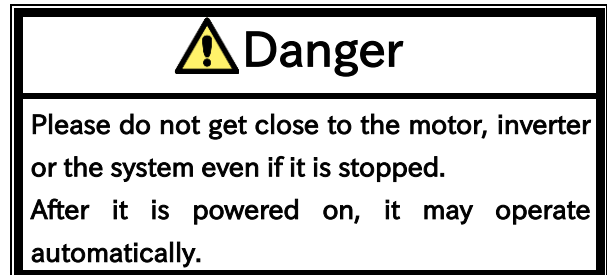

2

Chapter 2 Overview

Contents

2.1 About this chapter.....	2-1
2.2 Applicable devices	2-1
2.3 Before reading this guide.....	2-1
2.4 Guide objectives.....	2-1
2.5 Guide outline	2-1

2.1 About this chapter

This chapter specifies the devices that this guide will describe. Additionally, it contains information necessary to clearly understand this guide, the objectives of this guide and its terminology.

2.2 Applicable devices

The contents of this guide will apply to the P1-FB device. For other devices please refer to the corresponding manual or guide.

2.3 Before reading this guide

This guide is aimed for people who purchase, handle, install or connect control equipment, design systems or manage factories.
This guide uses the SI unit system.

2.4 Guide objectives

The objectives of this guide are:

- explain how to wire and connect the device.
- explain how to configure the device

2.5 Guide outline

This guide has the following structure.

- The chapter 1 “Safety Precautions” , contains the safety instructions for installing, wiring, operating, maintaining and inspecting this device.
- This chapter contains information necessary to clearly understand this guide, the objectives of this guide and its terminology.
- The chapter 3 “Preparing for Operation” , contains the instructions step by step for successfully operate this device
- The chapter 4 “About this Product” , contains the explanation about the product appearance and general features.
- The Chapter 5 “Bundled Items” contains information about the items included with this device.
- The Chapter 6 “Installing and connecting” , contains information for installing the P1-FB on the inverter
- The Chapter 7 “FAQ and Troubleshooting” , contains the explanation of inverter error (trip) status and its trouble shooting.
- The Chapter 8 “Specifications” contains the specifications of this product.

3

Chapter 3 Preparing for Operation

Contents

3.1 About this chapter.....	3-1
3.2 Preparation steps	3-1

3.1 About this chapter

This chapter contains the instructions step by step for operating this device successfully. This chapter will refer to others chapters for more detail explanation. Hence for installation, mounting, wiring, operation setting and function detailed explanation, refer to the indicated or corresponding chapter. Additionally, when doing any work or operation, always follow the safety instructions and cautions given in the chapter 1.

3.2 Preparation steps

Preparing the inverter

Follow the steps written in the inverter user's guide in order to prepare the inverter for operation.

Disconnection detection

Confirm is there any disconnection on A,B and Z phase.
Please refer to the Chapter 4.

Installing the P1-FB

Install the P1-FB and connect it to inverter.
Please refer to the Chapter 6.

Parameter setting

Turn on the inverter, set the inverter and configure the parameters related to the P1-FB. Furthermore, configure the parameters related to the motor.
For information about configuration of the inverter, please refer to the inverter user's guide.

4

Chapter 4 About the P1-FB

Contents

4.1 About this chapter.....	4-1
4.2 P1-FB overview and precautions	4-1
4.3 Appearance and each part name of the product	4-2
4.4 Wire disconnection detection	4-3
4.5 Name plate	4-3
4.6 Dimensions after installation	4-3

4.1 About this chapter

This chapter contains the explanation about this product external features and information on the name plate. It is recommended to check this chapter contents and verify the Device after the purchase.

4.2 P1-FB overview and precautions

P1-FB is an option cassette connected to the inverter which complies with the 5V line driver of the incremental rotatory encoder.

After connected to the inverter, P1-FB successfully detects the rotation speed of the motor equipped with an encoder and feedbacks to the inverter.

Thus, it contributes to suppressing the speed variation and helps to operate with high accuracy. In addition, such function can be realized such as position command, synchronous operation and orientation function. For further information, please refer to the inverter user's guide.

■ Precautions of using restart frequency matching function

Frequency matching function during restart or trip is decided by the free running rotational frequency detected by the residual voltage of the motor, and it is not based on the value of the encoder. If the free run continues when the residual voltage of the motor is 0, the inverter may restart at 0HZ, and may trip again.

The attenuation of the residual voltage for each motor is characteristic. If the motor have greater inertia respective to the load, much more attention should be paid.

■ Precautions when supplying power to encoder from another equipment other than P1-FB.

Please connect the public side of the power supply to the EG terminal of P1-FB.

Be sure to supply or cut power under the following sequences, otherwise it may cause unexpected malfunctions and it is dangerous.

- (power on)
- Put on the encoder power supply
- Put on the inverter (with P1-FB) power supply
- (power off)
- Cut down the inverter power supply with (P1-FB)
- Cut down the encoder power supply

When supply power to the inverter while the encoder is power off, it will lead to encoder wire disconnection. The trip history of the inverter is updated each time, so unexpected malfunctions may occurs, and it is dangerous due to malfunctions of the reduced life span of the inverter.

4.3 Appearance and each part name of the product

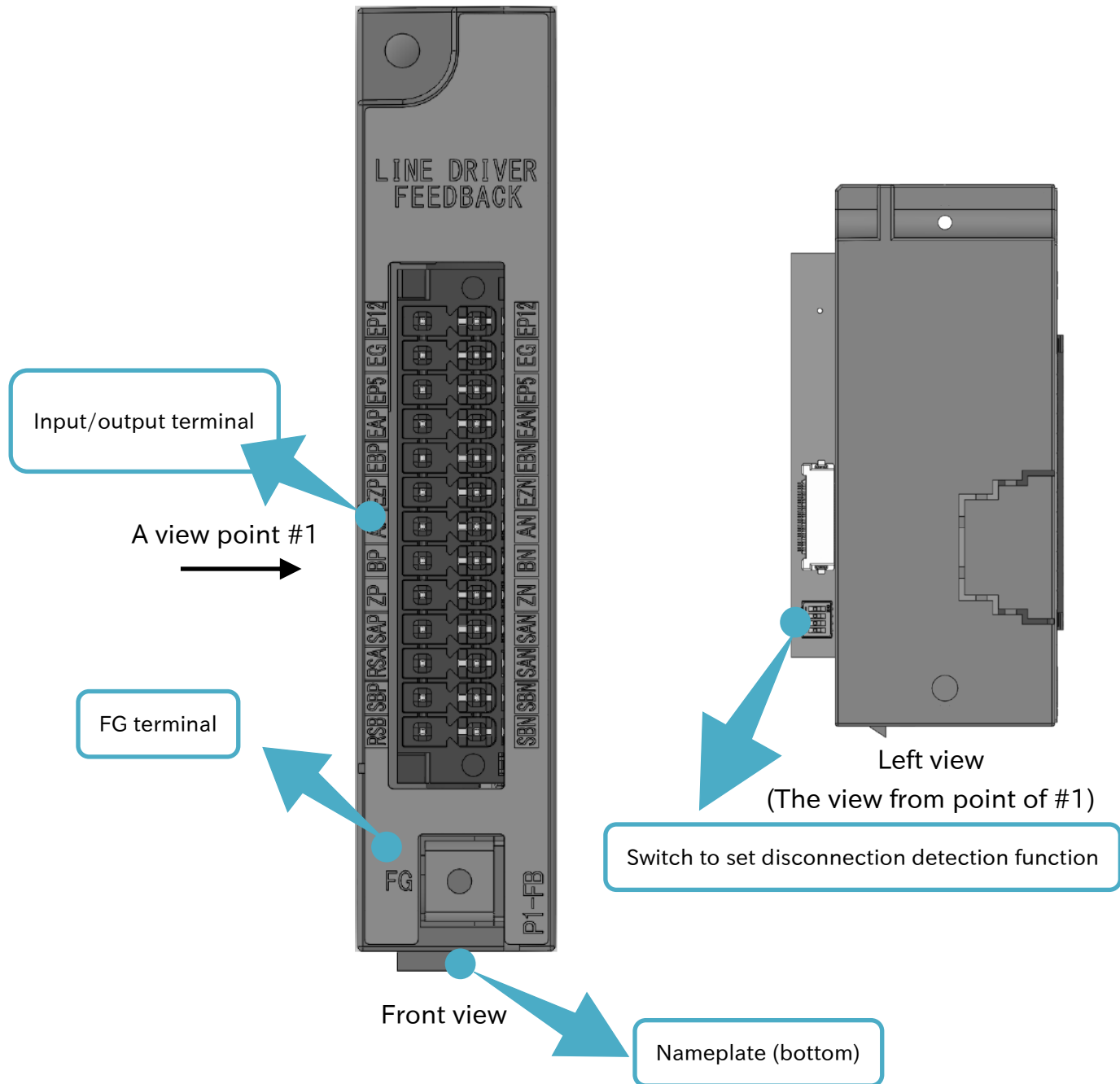

4.4 Wire disconnection detection

Use the switch on the left side of the inverter to set the disconnection detection function. See as below:

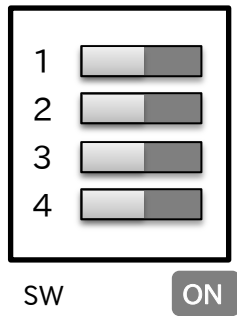

The above figure shows the switch is OFF, if push the switch to the right side, it will be turned on.

Switch No	Contents	
1	ON	Disconnection detection of A,B phase is enabled
	OFF	Disconnection detection of A,B phase is disabled
2	ON	Disconnection detection of Z phase is enabled
	OFF	Disconnection detection of Z phase is disabled
3	ON	Don't change
	OFF	
4	ON	Don't change
	OFF	

- ※ Ensure the factory set of all switch is OFF
- ※ Please set these items before installation

4.5 Name plate

The P1-FB name plate gives the following information.

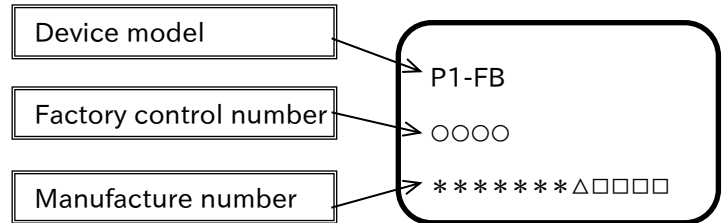

4.6 Dimensions after installation

The dimensions of the P1-FB after it is installed on the inverter are shown in the image below. As shown on the image, a part of the P1-FB will stand out from the SJ-P1. Please pay attention when installing the device.

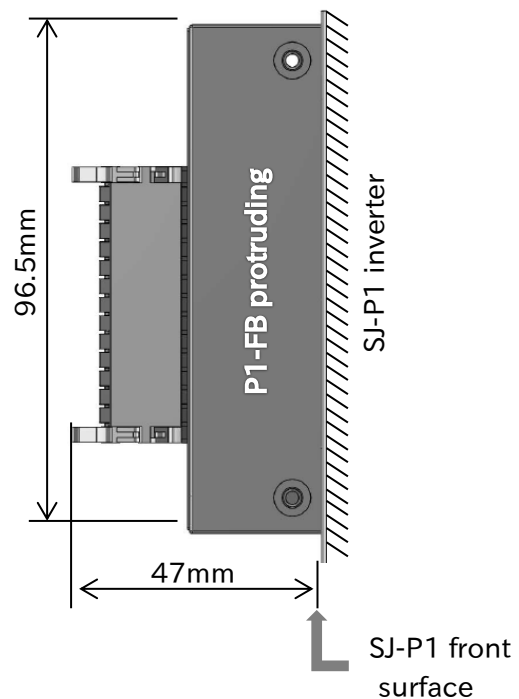

View from the right side of the SJ-P1

5

Chapter 5 Bundled Items

Contents

5.1 About this chapter.....	5-1
5.2 About the bundled items.....	5-1
5.3 Verification after the purchase.....	5-2
5.3.1 Verification when unpacking.....	5-2
5.3.2 About this guide	5-2

5.1 About this chapter

This chapter contains information about the items included with the P1-FB. Additionally, it is explained how to inspect and verify this product after its purchase.

5.2 About the bundled items

· Included items

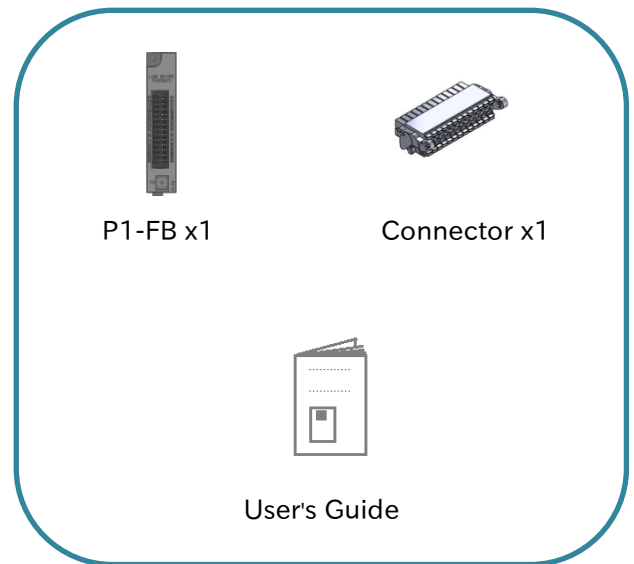

5.3 Verification after the purchase

5.3.1 Verification when unpacking

- Please verify the items written on the right when unpacking.
- In case there is any doubt or trouble with the product please contact your sales agent as soon as possible.

5.3.2 About this guide

- This guide contains the information necessary to handle the P1-FB correctly. Read it carefully and keep it safe.
- Also, use the inverter user's guide and basic guide as a reference.
- Please make sure that the P1-FB basic guide and the inverter basic guide reach the end user. Additionally, please advise the end user to download and read the latest version of this guide.

Check that the items were not smashed or damaged during the delivery.

Check that there is a P1-FB, there is a Basic Guide, there is a connector when unpacking.

Please check again that your order match with the name plate of the device.



Chapter 6 Installing and Connecting

Contents

6.1 About this chapter.....	6-1
6.2 Supported inverters	6-2
6.3 Installation.....	6-2
6.3.1 About the installation	6-2
6.3.2 How to install.....	6-3
6.4 About the wiring and connection	6-4

6.1 About this chapter

This chapter contains information for installing the P1-FB on the inverter.

For information about installation of the inverter, please refer to the inverter user's guide.

6.2 Supported inverters

The P1-FB can be attached to all types of SJ-P1. However, depending on the SJ-P1 manufacture date, it might not support the P1-FB. Please check the version of the inverter which is written on the name plate of it (the name plate example is shown on the image to the right). If the version is 2.00 or higher it can support the P1-FB

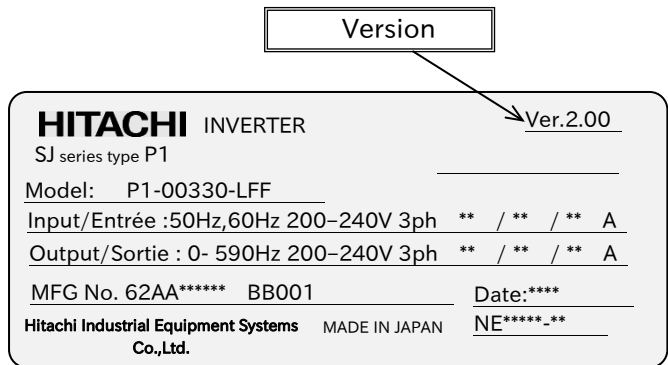

6.3 Installation

6.3.1 About the installation

The P1-FB can be attached to slot 2 of the SJ-P1 inverter.

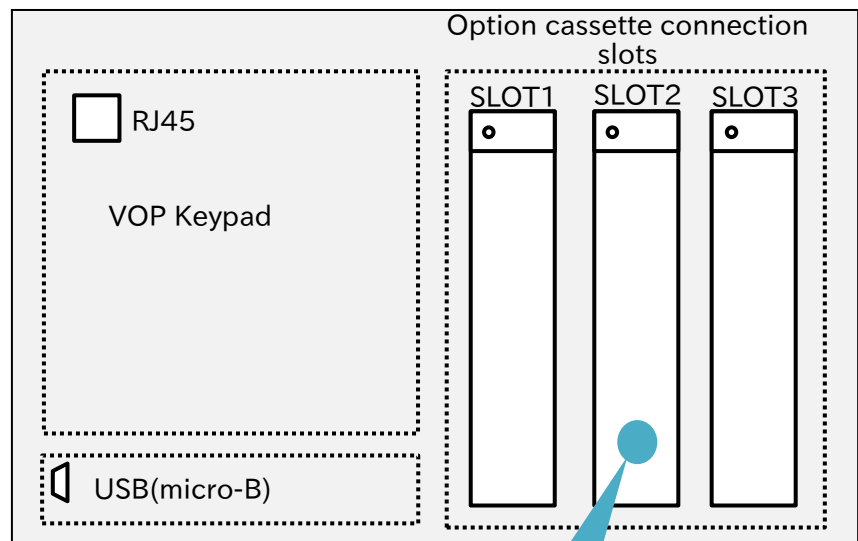
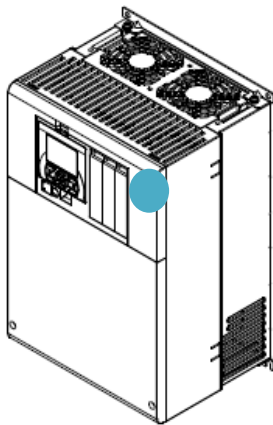

Only attach the P1-FB to SLOT2.

Note) P1-FB will not work when installed on SLOT1, because there is no electric connection.

Note) When installing P1-FB to SLOT3, the inverter and P1-FB may be damaged because of the interference of the connector.

6.3.2 How to install

- (1) Remove the cover of the option cassette connection slot. The removed cover will no longer be needed, so keep it in a safe place. However the screw that secured the cover will be used to secure the P1-FB.

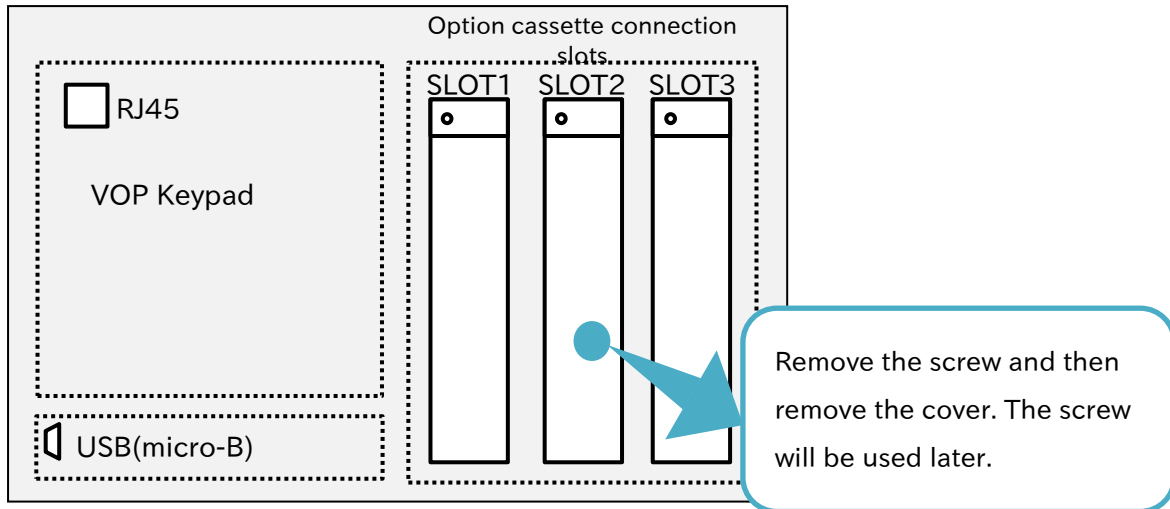

- (2) Attach the P1-FB. The slot has one more connections on the upper side. However, the P1-FB will not need that connection.

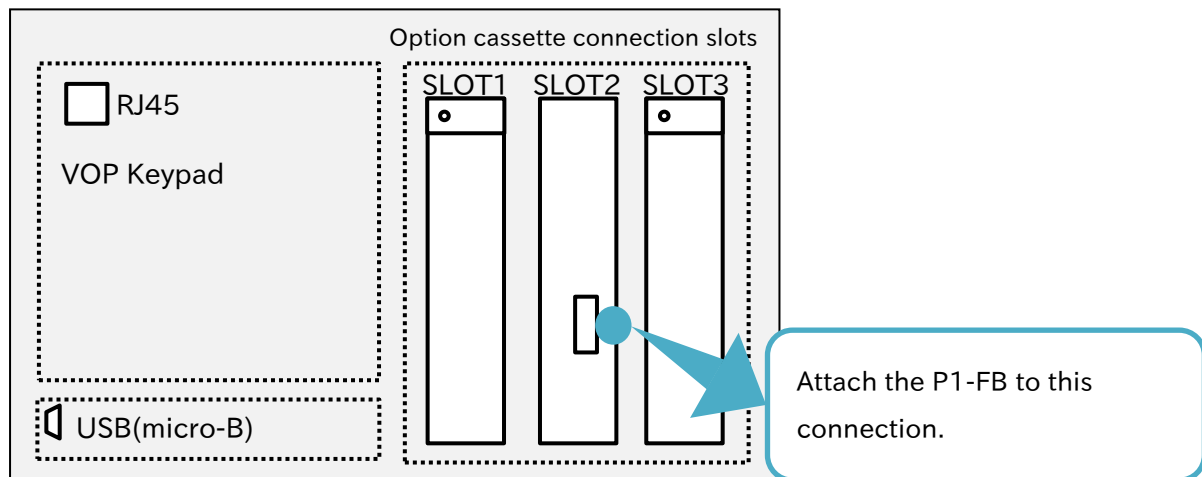

- (3) Secure the P1-FB with the screw removed in (1), and connect to the FG functional ground.

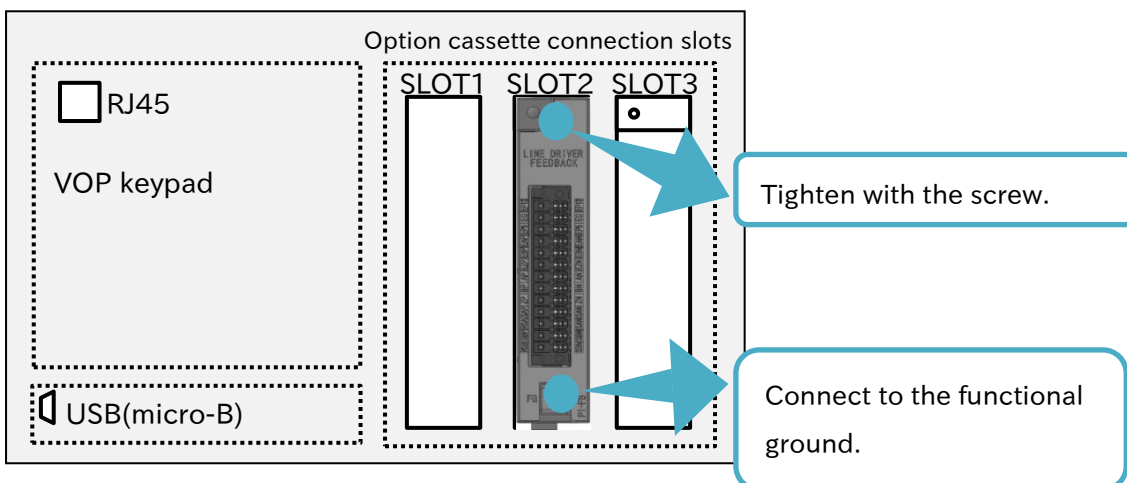

6.4 About the wiring and connection

■ Terminal sequence

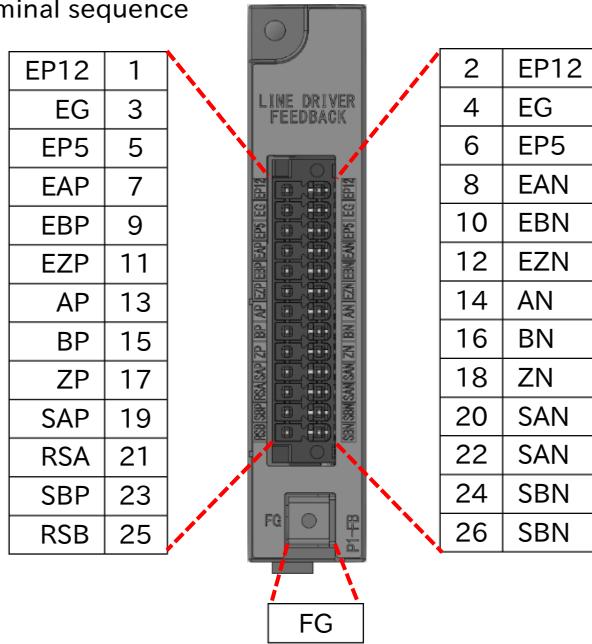

■ Specifications

Terminal names	Marks	Functions		
		Common terminal	Specifications	
Input terminals	Pulse line position common input	SAP SAN SBP SBN RSA RSB	<ul style="list-style-type: none"> Pulse train input methods <ul style="list-style-type: none"> MD 0 : 90° phase differential pulse MD 1 : forward/reverse signal, pulse string MD 2 : forward pulse/reverse pulse Set pulse train input mode P013. RSA : Terminal resistor for SAP and SAN terminal RSB : Terminal resistor for SBP and SBN terminal How to set terminal resistor <ul style="list-style-type: none"> Embedded terminal resistor : 150Ω switch enable/disable by wire RSA, RSB terminal open : built in terminal resistor disabled RSA-SAN short circuit, RSB-SBN short circuit : built in terminal, enabled 	DC5V receiver input (based on RS-422 standard)
	Encoder signal input	EAP EAN EBP EBN EZP EZN	A, B, Z : Rotary encoder signal input	Photo-coupler input (Correspondence to the DC5V line driver type rotary encoder)
Output terminals	Encoder signal output	AP AN BP BN ZP ZN	It output pulse signal from encoder input by (1:1) ratio	DC5V line driver output (based on RS-422 standard)
	Encoder power supply	EP5 EP12	DC+5V power supply DC+12V power supply	EG The total supply capacity of EP5, EP12 is 250mAmax
Functional ground terminal	FG	Please connect to the functional ground (the screw size is M3)		

■ Recommended terminals

In order to make convenience to wiring and improve the connection, it's recommended to use the ferrule terminals with the following specifications for signal wire.

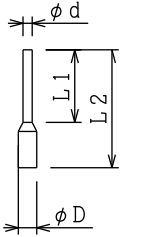
Wire diameter mm2 (AWG)	Ferrule terminal specifications *	L1 [mm]	L2 [mm]	ϕd [mm]	ϕD [mm]	
0.25 (24)	AI 0,25-10 YE	10.0	14.5	0.8	2.0	
0.34 (22)	AI 0,34-10 TQ	10.0	14.5	0.8	2.0	
0.5 (20)	AI 0,5-10 WH	10.0	16.0	1.1	2.5	
0.75 (18)	AI 0,75-10 GY	10.0	16.0	1.3	3.4	

*) Manufacturer : Phoenix

Crimping tool CRIMPFOX 6

※Noted that these specifications are different from the recommended ferrule terminals for the inverter.

■ Wiring connections

Insert

Insert the ferrule terminal into the P1-FB terminal block. It will be easy to insert without any tools if use the correct ferrule terminals.

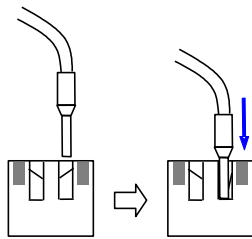

Wire inserted

■ Methods to detach the connector

Put down the locking lever according to the arrow direction to unlock and pull out the connector, as showed below.

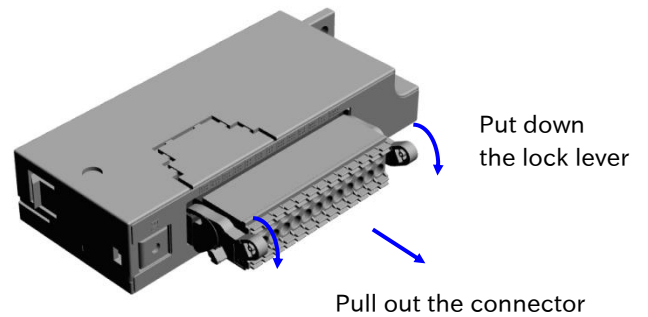

Put down the lock lever

Pull out the connector

Pull out the wire

Press the grey part on P1-FB terminal block with flat screwdriver (width lower than 2.5m) to open the wire port.

Press the flat screwdriver and pull out the wire or the ferrule terminal

Pull out the flat screwdriver.

The real color of the grey part on the terminal block is orange.

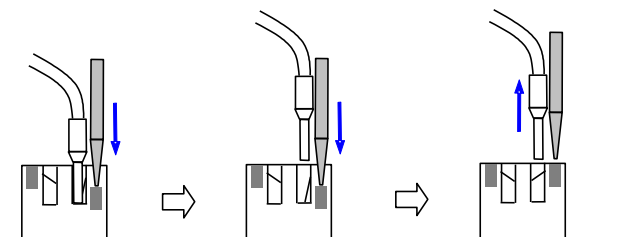

Press the grey part with flat screwdriver

Pull out the wire

Pull out the flat Screw driver

■ Wiring diagram and some notes

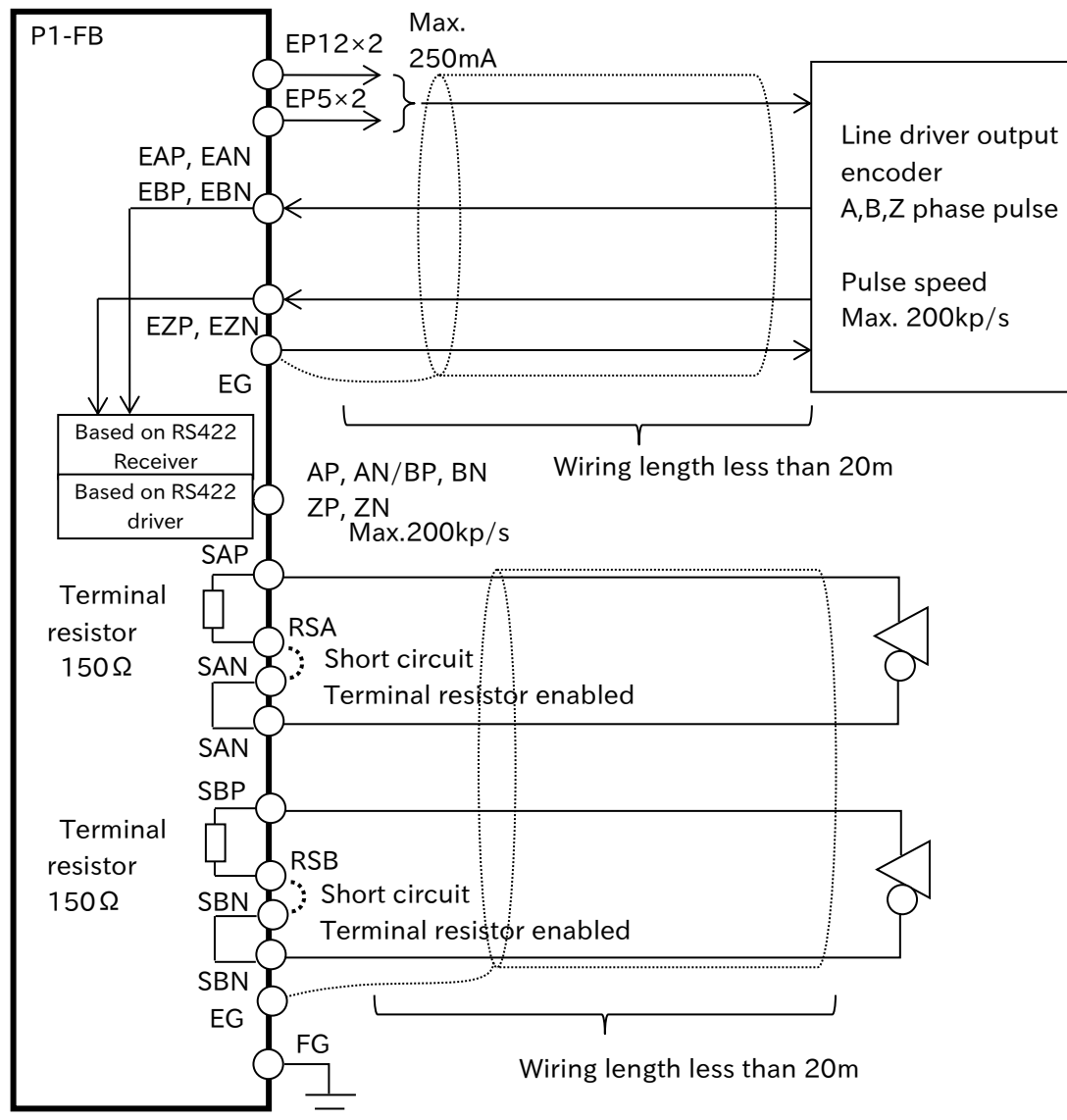

- Ensure that the length between encoder and P1-FB is less than 20m
- Use twisted pair wire
- Connect the shielded wire of the encoder to the EG terminal of P1-FB
- If incorrectly shielded, the inverter may malfunction because of external interference. Normally, the shielded wire should be connected to common signal terminals or ground terminal out of the inverter case. Avoid multiple grounding.
- Connect the FG terminal of P1-FB to functional ground.
- When transiting through the encoder power supply terminal of P1-FB with relay amplifier, be sure the wiring length between relay amplifier and P1-FB is less than 20m.
- When connecting the relay amplifier to P1-FB, please connect the shield wire to the EG terminal of P1-FB.
- Regarding the detail information for connection between relay amplifier and the encoder, please confirm with the manufacturer on the input specifications before connection.
- When the wiring length of P1-FB is more than 20m, the inverter may malfunction because of external interference. Be care of the wiring of the relay amplifier.
- When connecting the power supply of encoder to another equipment than P1-FB, please connect the common terminal of the encoder power supply to the EG terminal of P1-FB.

Regarding other installation methods, please refer to the User's guide of the inverter.



Chapter 7 FAQ and troubleshooting

Contents

7.1 About this chapter.....	7-1
7.2 Self-diagnosis.....	7-2
7.3 P1-FB troubleshooting.....	7-3

7.1 About this chapter

This chapter contains the troubleshooting of cases such as errors detected by the protection function, warnings given by the warning function, or some cases in which the device is not working properly.

7.2 Self-diagnosis

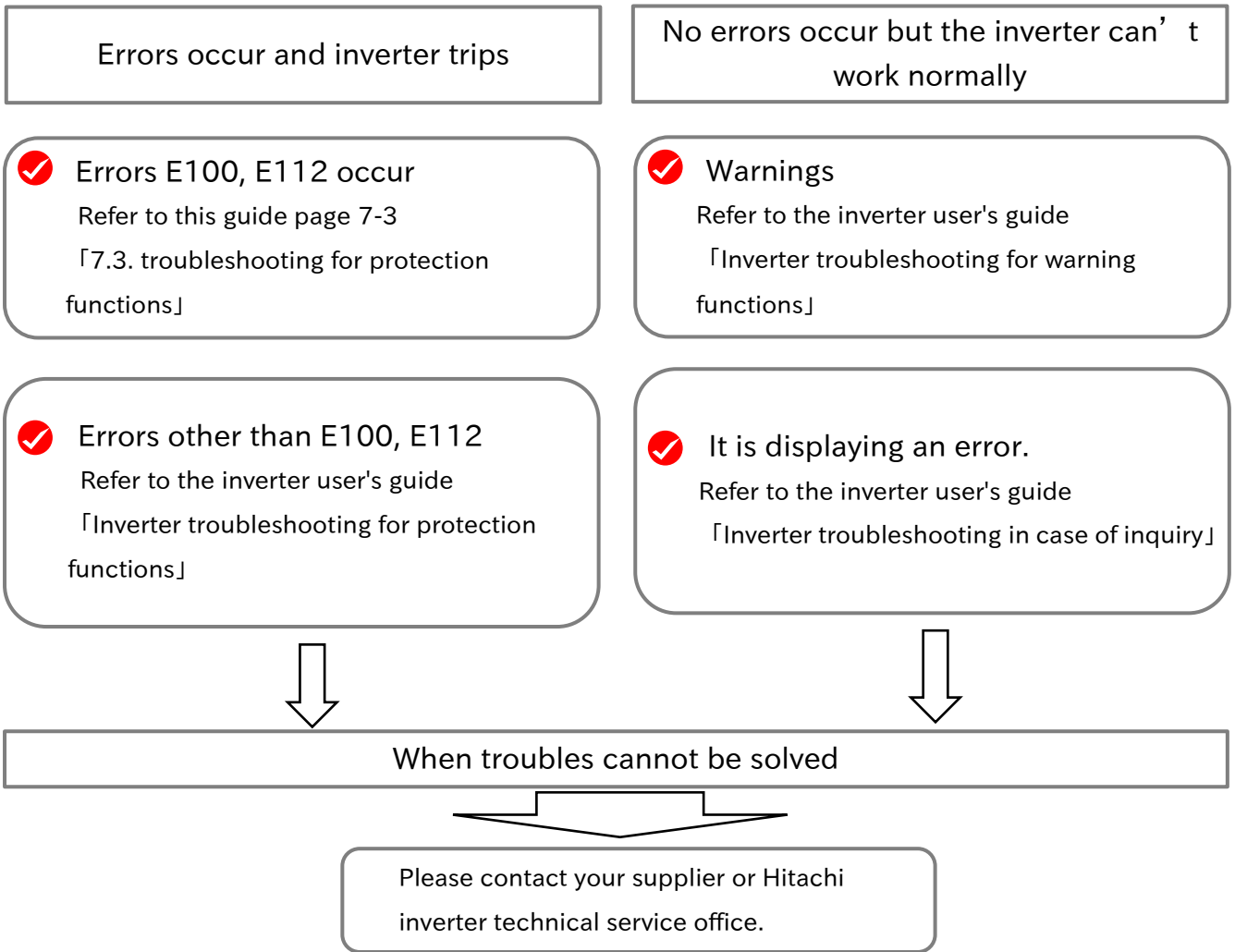

Before contacting the technical service, please confirm the items on the right.

- (1) Inverter model,
- (2) Inverter manufacture number (MFG No.),
- (3) Purchase date of the inverter,
- (4) Option model (P1-FB),
- (5) P1-FB manufacture number (MFG No.),
- (6) Purchase date of P1-FB,
- (7) Inquiry content.

For information about how to check the inverter model and the manufacture number (MFG No.), please refer to the inverter user's guide.
For information about how to check the P1-FB model and the manufacture number (MFG No.), please refer to the chapter 4.

7.3 P1-FB troubleshooting

E100

Encoder disconnection

Set the switch on the feedback option of P1-FB, the inverter may trip when E100 error occurs. Please refer to Chapter 4 for detail information.

E100

Conditions▶	Reasons▶	Example of troubleshooting
Occurs during power on.	<ul style="list-style-type: none"> Encoder wire or the encoder malfunction. 	<ul style="list-style-type: none"> Confirm the signal or wiring of the encoder. When using external encoder power supply, please confirm whether the encoder power supply starts longer than that of the inverter.
Suddenly occurs during operation.	<ul style="list-style-type: none"> Encoder wire or the encoder malfunction. 	<ul style="list-style-type: none"> Confirm the signal or wiring of the encoder.
Occurs during power off. This error history will be added when power on.	<ul style="list-style-type: none"> Occurrence of abnormality in an internal inverter or encoder power supply malfunction. 	<ul style="list-style-type: none"> When using encoder the power supply of the inverter, please confirm whether there are any inverter errors or overload of the encoder power supply. Regarding the specification of encoder power supply, please refer to 4.3.2 input/output terminal. When using external encoder power supply, please confirm whether the encoder power supply is power off earlier than the inverter.

E112

FB option connection error

When the [E112] error occurs, the inverter will trip because of P1-FB falls from the option cassette.

E112

Conditions	Reasons ▶	Example of troubleshooting
Suddenly occurs during operation.	<ul style="list-style-type: none"> The connector falls off. 	<ul style="list-style-type: none"> Please confirm whether the screw on P1-FB is tightened. Please confirm whether the connector is normally operating or dusted.

8

Chapter 8 Specifications

Contents

8.1 About this chapter.....	8-1
8.2 Product specifications	8-1

8.1 About this chapter

This chapter contains information about the P1-FB specifications.

8.2 Product specifications

Item		Specifications	
Model		P1-FB	
Demension (Width×Height×Depth)		20.5×98.0×70.0mm	
Weight		170g	
Environment	Ambient temperature	-10~50°C	No icing and condensation conditions
	Ambient humidity	20~90%RH	
	Storage temperature *1)	-20~65°C	
	Vibration tolerance	5.9m/s ² (0.6G)、10~55Hz	
	Conformance to EMC and electrical safety standards	IEC/EN61800-3 Second environment, Category C3 IEC/EN61800-5-1 SELV	
	Enclosure rating	IP00	
Encoder feedback		<ul style="list-style-type: none"> standard encoder pulse train value 1024 pulse/r maximum input pulse train value 200k pulse /s 	
Position command		<ul style="list-style-type: none"> maximum input pulse train value 200k pulse /s 	
Protection function		<ul style="list-style-type: none"> Encoder cable wire disconnection protection P1-FB disconnection 	

*1) Storage temperature is the temperature during transport.