

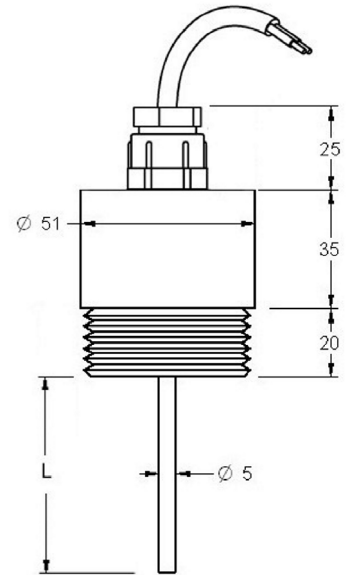

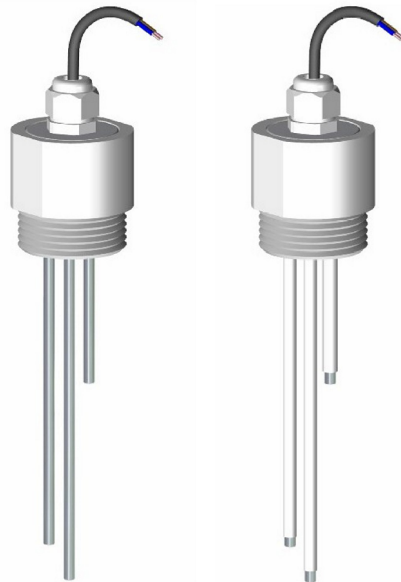





NRA 1"1/2 PG9 / NRAI 1"1/2 PG9

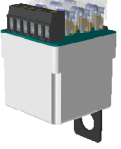

CONDUCTIVE ELECTRODES

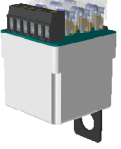

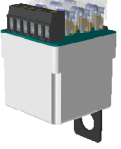































Description	Set of electrodes for the control of the level in conductive liquids. Usable in all type of tanks, opened or closed.																
Body material / colour	PTFE / white																
Electrode	SS AISI316 (1.4401). Ø 5 mm. Optional Titanium. The number of electrodes depends on the function of the required level control. Consult the specific characteristics of each level relay.																
Electrode length	Standard, 1000 mm. Others lengths on request. All the electrodes are delivered at the same length. For setting the level detection points, cut each electrode to the required height. Keep in mind that the common electrode must have a length equal or longer than whichever other one.																
Process connection	Top screw 1"1/2 G																
Electrical connection	By Silicone cable. Output through IP66 cable gland. Length 3 m (other lengths on request).																
Maximum temperature	+100 °C																
Pressure	1 Kg/cm ² (to 20 °C)																
Electrode insulation	Optionally, the electrodes can be protected with Poliolefine insulation to guarantee the set detection points.																
Protection	IP66																
Usable with	Level relays for conductive liquids: relays families PN, DN and SN (see next page).																
 Warning	DISIBEINT ELECTRONIC SL is not responsible of the electric behavior of these electrodes when using control relays belonging another manufacturers.																
Reference composition	<table border="1"> <thead> <tr> <th colspan="2"></th> <th>Nr. Electrodes</th> </tr> </thead> <tbody> <tr> <td>NRA</td> <td rowspan="5">1"1/2 - PG9</td> <td>1E</td> </tr> <tr> <td></td> <td>2E</td> </tr> <tr> <td></td> <td>3E</td> </tr> <tr> <td>NRAI (insulated)</td> <td>4E</td> </tr> <tr> <td></td> <td>5E</td> </tr> </tbody> </table> <p>To compose the reference, select one option of each column. Example: NRA 1"1/2-PG9 2E</p>					Nr. Electrodes	NRA	1"1/2 - PG9	1E		2E		3E	NRAI (insulated)	4E		5E
		Nr. Electrodes															
NRA	1"1/2 - PG9	1E															
		2E															
		3E															
NRAI (insulated)		4E															
		5E															
Accessories	<table border="1"> <thead> <tr> <th>NUT</th> <th>SEPARATOR</th> <th>PS-3</th> </tr> </thead> <tbody> <tr> <td></td> <td></td> <td></td> </tr> <tr> <td>Nut for attachment</td> <td>Electrodes separator</td> <td>Overvoltage protector for the probes line</td> </tr> <tr> <td>NR.TUE/P 1"1/2 - PTFE - White</td> <td>NR.SEP/P - PTFE - White</td> <td>PS3 - Noryl (housing box) - Light grey</td> </tr> </tbody> </table>			NUT	SEPARATOR	PS-3				Nut for attachment	Electrodes separator	Overvoltage protector for the probes line	NR.TUE/P 1"1/2 - PTFE - White	NR.SEP/P - PTFE - White	PS3 - Noryl (housing box) - Light grey		
NUT	SEPARATOR	PS-3															
																	
Nut for attachment	Electrodes separator	Overvoltage protector for the probes line															
NR.TUE/P 1"1/2 - PTFE - White	NR.SEP/P - PTFE - White	PS3 - Noryl (housing box) - Light grey															
Function																	
Reference - Material - Colour																	

Rev. 02/00 - 26/10/16 - DISIBEINT reserves the right to modify the specifications stated in this document without previous notice

LEVEL RELAY FOR CONDUCTIVE LIQUIDS

- Electrode holder compact and exclusive use electrodes in conductive liquids.
- Used level control points independent or combined among themselves in low-lying deposits.
- They need to connect to a level relay for conductive liquids
- The number of electrodes is determined by the chosen relay function

				
	PNSA	DNSA	SNSA	
	<ul style="list-style-type: none"> · Control of level maximum and/or minimum · General application · Sensitivity: 10..100Kohms · Voltage/Current (probes): 24 VAC/4 mA 			
	PNFA	DNFA		
	<ul style="list-style-type: none"> · Combined control of phase failure and maximum and/or minimum level · Sensitivity: 10..100Kohms · Voltage/Current (probes): 24 VAC/4 mA 			
	PNCA PNCB	DNCA DNCB		 
	<ul style="list-style-type: none"> · Supply voltage DC or AC · Doble contact of relay · Control of maximum and/or minimum level · Sensitivity: 8..45 Kohms · Voltage/Current (probes): 6,2 VAC/3,2 mA 			
	PNEA	DNEA		
	<ul style="list-style-type: none"> · For high resistivity liquids: distilled water, demineralized... · Maximum and/or minimum level · Two ranges of sensitivity: 10..100 Kohms / 200 Kohms..4,7 Mohms · Voltage/Current (probes): 24VAC/4mA 			
	PNDA	DNDA		
	<ul style="list-style-type: none"> · Automatic control of well and tank · Sensitivity: 10..100 Kohms · Voltage/Current (probes): 24 VAC/4mA 			
	PNGA	DNGA		 
	<ul style="list-style-type: none"> · Double level control · Two controls of independents levels · Contacts NO · Maximum and/or minimum level · Sensitivity: 10..100 Kohms · Voltage/Current (probes): 24 VAC/4 mA 			
	PNHA	DNHA		 
	<ul style="list-style-type: none"> · Double level control · Two controls of independents levels · Contacts NC · Maximum and/or minimum level · Sensitivity: 10..100 Kohms · Voltage/Current (probes): 24 VAC/4 mA 			
			SNDA	 
	<ul style="list-style-type: none"> · Two independent level controls · Contacts NO/NC · Maximum and/or minimum level · Sensitivity: 10..100 Kohms · Voltage/Current (probes): 24 VAC/4 mA 			
			SNZA	  
	<ul style="list-style-type: none"> · Control of 3 independent levels, from the same tank or not · Many application possibilities · Independent settings for each relay · Max-Min function or by level point · Timing to detection level: 0..10s · Sensitivity: 1..100Kohms · Voltage/Current (probes): 5 VAC/4 mA 			
			MNZA	  
	<ul style="list-style-type: none"> · Three independent level controls · Contacts NO/NC · Maximum and/or minimum level · Without box. For direct mounting on rail DIN · Sensitivity: 10..100 Kohms · Voltage/Current (probes): 24 VAC/4 mA 			