

NCVR TB INOX / NCVRI TB INOX

CONDUCTIVE ELECTRODES WITH BUILT-IN AMPLIFIER



Application		Level control of general purpose for conductive liquids. The housing contains the built-in amplifier reducing costs, installation time and easing the start-up. The operating mode depends on the number of electrodes: · With 2 electrodes: one level detection (amplifier KNPA). See page 2. · Con 3 electrodos: maximum/minimum detection (amplifier KNCA). See page 3.
Operating principle		The sensor uses the rods to detect the liquid contained into the tank from which the level is to be controlled. The detection of such level or the lack of it provokes the reaction of a relay. A timing can be added to delay the detection in tanks with shaking mechanisms or with turbulences. In order to facilitate the adaptation to the characteristics of the installation, the state of the relay constacts can be selected.
Sensor	Process connection	Top screw 1" G. Stainless steel AISI316.
	Electrode	Stainless steel AISI316. \varnothing 5 mm.
	Electrode length	1000 mm.
	Volt./Cur. in electrodes	5 V _{pp} / 4 mA (in shortcircuit)
	Process temperature	-20..+70 °C. Other temperatures, please consult.
	Process pressure	5 Kg/cm ²
	Sensitivity	Adjustable between 1..100 K Ω (1000 μ s..10 μ s) (See table).
	Electrodes coating	The models referenced NCVRI are supplied with protective coating of PTFE to assure the detection in the right set points.
Housing	Material and dimensions	PBT. 64 x 95 x 110 mm
	Protection	IP67
	Temperature	-20..+50 °C
	Cable gland	M20 x 1,5 (IP68)
Output	Type	SPDT relay 6A/250VAC
	Response time	· At power on: 800 ms · At liquid detection: 500 ms
	Timing	Adjustable between 0..9 s. Can be set at detection, at undetection or at both situations.

Sensitivity ranges

Sensitivity	Detecting (\leq kohm)	Undetecting (\geq kohm)
0	1	2
1	6	12
2	12	24
3	17	34
4	23	46
5	28	56
6	34	68
7	39	78
8	45	90
9	50	100

REFERENCE		PROCESS CONNECTION				SUPPLY VOLTAGE		ELECTRODE						
NCVR	Level sensor	TB	Top screw	I	SS AISI316	P06	1" G	024	24 VCA	2 E	2 Electrodes	1000	1000 mm	
								048	48 VCA					
NCVRI	Level sensor (electrode isolated)	TB	Top screw	I	SS AISI316	P06	1" G	110	110..125 VAC	3 E	3 Electrodes	1000	1000 mm	
									230					220..240 VAC
									901					15..70 VAC/DC
								902	60..240 VAC/DC					

To compose a reference, select one option of each column. Example: NCVR TB INOX P06 024 1E L1000

NCVR TB INOX































2 Electrodes

1 level control

Start-up and adjustment

Prior to start working with the sensor NCVR, it must be adjusted for getting a right operation. Adjustments can be modified whenever required. It must be taken into account that the behaviour of the device can be different whether the adjustments are done while the electrodes are in touch or not with the liquid.

Be sure that the options selector is right positioned. Each time that it is moved to a new option, the  led flashes twice indicating that the option has been correctly reached.

Default values		The sensor is adjusted by default with values that can be used in a large number of applications. When pressing the push-button PROG the led  turns on. Keep the push-button pressed until the led  turns off (3 seconds), indicating that the default values have been reset (they are framed with  at the left column).
Sensitivity adjustment	 	When accessing to this option, the led  emits as many flashes as the adjusted sensitivity value, between 0 and 9. Each time the push-button PROG is pressed, the sensitivity value increases in 1, except when the value is 9 that moves to 0. If it is pressed longer than 3 seconds, the sensitivity value moves to 0.
State of the relay contacts	 	See the table "Sensitivity ranges" at the first page to relate each digit with its ohmic value. (Relay NO (): led  OFF; Relay NC (): led  ON). When accessing to this option, the led  shows the actual state of the adjustment. Each time the push-button PROG is pressed, it is reversed the state of the relay contacts. WARNING: This option modifies the state of the relay and this could provoke undesired effects in the case that any device be connected to the contacts of the relay.
Timing type	 	(Detecting (): led  OFF; Undetecting (): led  OFF; Detecting and undetecting (): led  flashing). When accessing to this option, the led  shows the actual state of the adjustment. Each time the push-button PROG is pressed, it is moved to the next timing type in a cyclic way.
Time	 	When accessing to this option, the led  emits as many flashes as the number of seconds adjusted in the timer, between 0 and 9 seconds. Each time the push-button PROG is pressed, the time value increases in 1 second, except when the value is 9 that moves to 0. If it is pressed longer than 3 seconds, the time value moves to 0.
Run		Normal operation mode. The state of the led  matches with the state of the relay contact (led ON = relay ON).

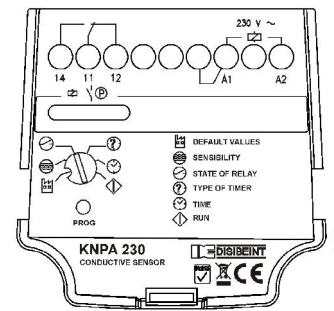

Assembly conditions

Electrodes: The electrodes can be cut to reach the required detection height. Because the detection point is unique, it is recommended to cut them at the same length. During the cutting process, be careful in preserving the housing of mechanical stress that may damage the binding of the electrode with the electronic circuitry.

Mounting position: The sensor can be mounted in any position. In the case of mounting at the tank side, it is suggested to use the model NCVRI with isolated electrodes, that will prevent an undesired communication through the deposition of liquid on the electrodes. In the same way, if the rods are very large (more than 1 meter, usually), it is recommended to use the separator NR.SEP/P to keep the electrodes isolated while the liquid is not in contact with them.

Handling: Do not use the housing to screw the sensor into the fitting. Use a tool 40 mm wide at the steel part on the thread. Once tightened, you can turn the housing 350° with your hand until it be placed in the right position.

Electrical connection: Use a cable according with the load the relay will manage. It is convenient that the cable gland completely tight the cable of the electrical connection, and it becomes essential in the event of humidity or when installed outdoor. In these cases, make a loop in the cable to facilitate the removal of accumulated drops (see figure).

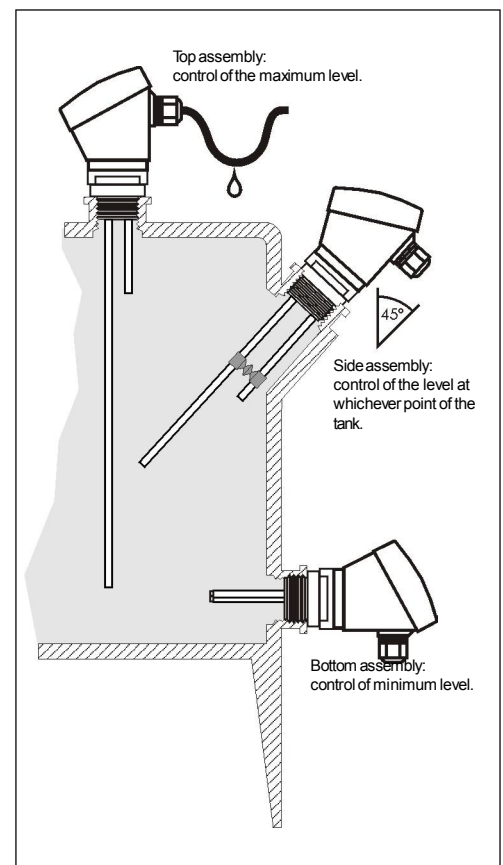

NCVR TB INOX

3 Electrodes

Max / Min



Start-up and adjustment

Before to start-up the sensor NCVR it must be adjuste to get a right operation.

Adjustments can be modified whenever needed. Must be tanken into account that the sensor behaviour can change whether the adjustments are done while the electrodes are in contact with the liquid or not.

Be sure that the options selector is right positioned. Each time it is moved to a new option, the led  flashes twice indicating that this option has been correctly reached.

Default values

The sensor is adjusted by default with values that can be used in a large number of applications. When pressing the push-button PROG the led  turns on. Keep the push-button pressed until the led  turns off (3 seconds), indicating that the default values have been reset (they are framed with  at the left column).





Sensitivity adjustment

5

When accessing to this option, the led  emits as many flashes as the adjusted sensitivity value, between 0 and 9. Each time the push-button PROG is pressed, the sensitivity value increases in 1, except when the value is 9 that moves to 0. If it is pressed longer than 3 seconds, the sensitivity value moves to 0.

See the table "Sensitivity ranges" at the first page to relate each digit with its ohmic value.

State of the relay contacts

(Relay NO (): led  OFF; Relay NC (): led  ON). When accessing to this option, the led  shows the actual state of the adjustment. Each time the push-button PROG is pressed, it is reversed the state of the relay contacts.

WARNING: This option modifies the state of the relay and this could provoke undesired effects in the case that any device be connected to the contacts of the relay.

Run

Normal operation mode.

The state of the led  matches with the state of the relay contact (led ON = relay ON).

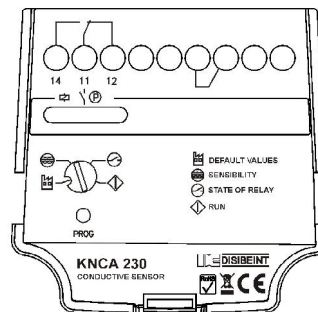
**Assembly conditions**

Electrodes: The electrodes can be cut to reach the required detection height. The common electrode must be the largest one and it is identified with the number "2" at the bottom side of the top screw (see figure). The electrode for minimum level must be equal or shorter than the common one. During the cutting process, be careful in preserving the housing of mechanical stress that may damage the binding of the electrode with the electronic circuitry.

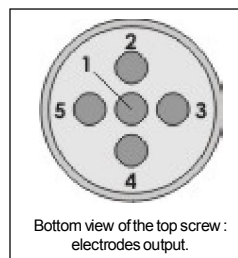

Bottom view of the top screw :
electrodes output.

Mounting position: The sensor can be mounted in any position. In the case of mounting at the tank side, it is suggested to use the model NCVRI with isolated electrodes, that will prevent an undesired communication through the deposition of liquid on the electrodes. In the same way, if the rods are very large (more than 1 meter, usually), it is recommended to use the separator NR.SEP/P to keep the electrodes isolated while the liquid is not in contact with them.

Handling: Do not use the housing to screw the sensor into the fitting. Use a tool 40 mm wide at the steel part on the thread. Once tightened, you can turn the housing 350° with your hand until it be placed in the right position.

Electrical connection: Use a cable according with the load the relay will manage. It is convenient that the cable gland completely tight the cable of the electrical connection, and it becomes essential in the event of humidity or when installed outdoor. In these cases, make a loop in the cable to facilitate the removal of accumulated drops (see figure).

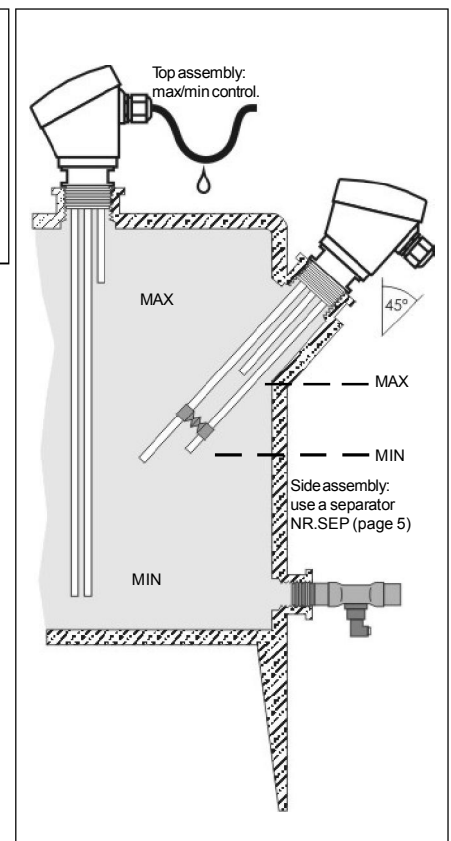

Model



NCVR TB INOX 2E
NCVRI TB INOX 2E

- 2 Electrodes
- Amplifier *KNPA*



NCVR TB PVC 3E
NCVRI TB PVC 3E

- 3 Electrodes
- Amplifier *KNCA*

Operating diagrams

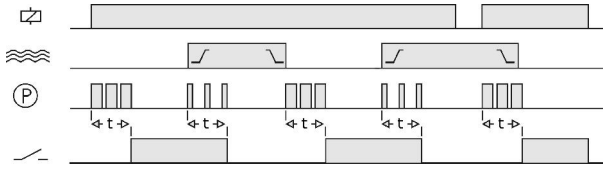

Simulation: Control of maximum level or filling
Relay contacts: NC
Timing type: Detecting and undetecting
Time: Any value greater than 0

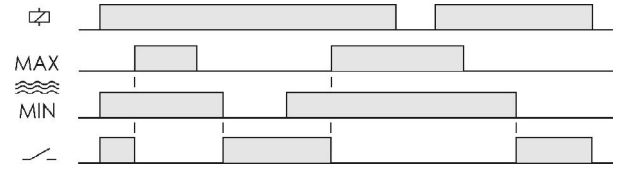

Simulation: Control for filling
Relay contacts: NC

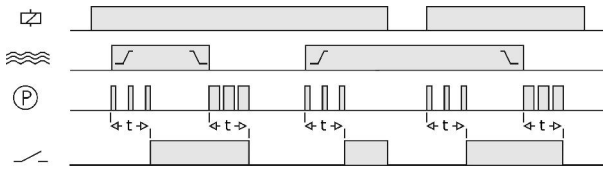

Simulation: Control of minimum level or emptying
Relay contacts: NO
Timing type: Detecting and undetecting
Time: Any value greater than 0

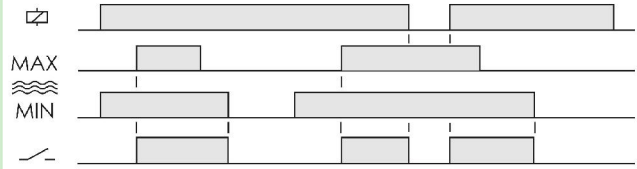

Simulation: Control for emptying
Relay contacts: NO

Example of wiring connection

Control of maximum level or filling control using a sensor with 2 electrodes and the amplifier KNPA.

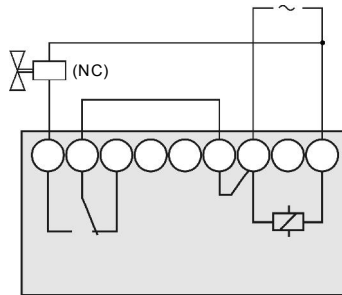

Filling control using a sensor with 3 electrodes and the amplifier KNCA.

Installation examples

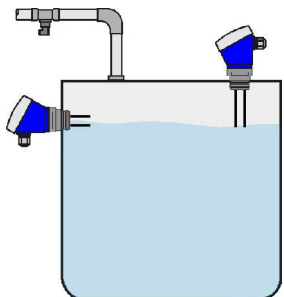

Detection of maximum level

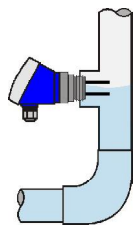

Detection of liquid inside the pipes

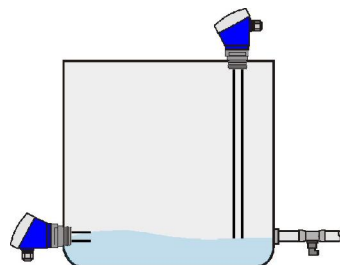

Detection of minimum level

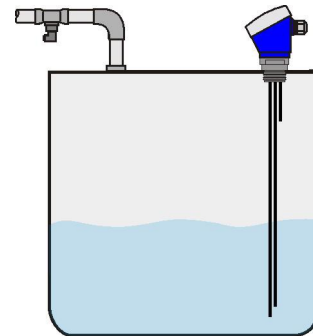

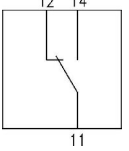
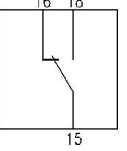

Detection of maximum and minimum level

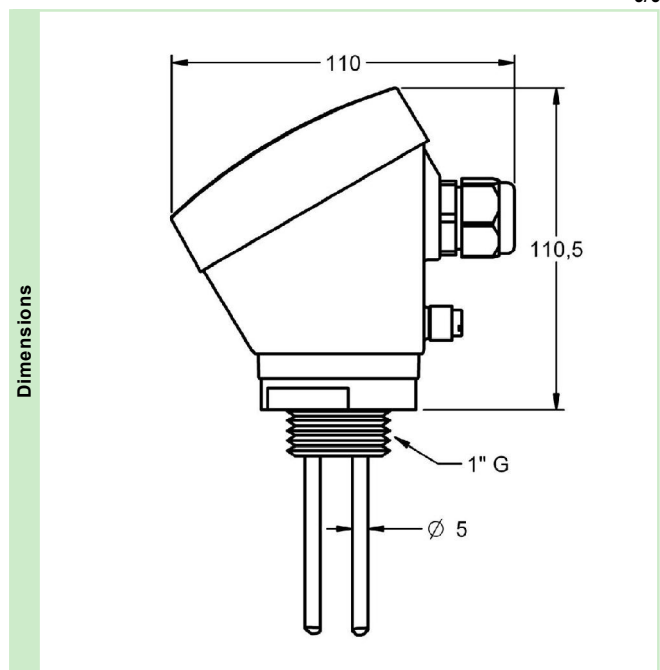
		KNCA	KNPA
			
Output relay	Resistive load	AC	6 A / 250 V
		DC	0,2 A / 200 V
	Inductive load	AC	6 A / 24 V
		DC	3 A / 250 V
	Mechanical life		> 30 x 10 ⁶ operations
	Max. mechanical operations		72.000 operations / hour
	Electrical life at full load		360 operations / hour
	Contact material		AgNi 0.15
	Maximum voltage		400 VAC
	Operating voltage		400 VAC
	Volt. between changeovers		1000 VAC
	Voltage between contacts		1000 VAC
Voltage coil/contact		4000 VAC	
Distance coil/contact		8 mm	
Isolation resistance		> 10 ⁴ MΩ	



		KNCA / KNPA
Constructive and environmental data	Voltage phase-neutral	300 V
	Overvoltage category	III
	Shocking voltage	4 kV
	Pollution degree	2
	Protection class	IP 20
	Storing temperature	-50..+85°C
	Operating temperature	-20..+50°C
	Humidity	30..85% HR
	Housing	Cycoloy - Light Grey
	Socket	Lexan - Light Grey
	Leds window	Lexan - Transparent
	Buttons and terminal blocks	Technyl - Dark Blue
	Terminals	Nickled brass
	Norms	Designed and manufactured under EEC standards. Directive for electromagnetic compatibility 2004/108/EEC. Directive for low voltage 2006/95/EEC. Plastics: UL 91 V0

		PTFE	Poliiolefine PE
Insulation	Application	Electrodes protection against possible contacts among them.	
	Colour	White	Grey
	External diameter (approx.)	8 mm	7 mm
	Temperature	+140°C	+70°C
	Models	NCPRI CB ... T	NCPRI CB ... L

		NR.SEP/P	NR.SEP/T
Accessories			
	Application	Electrodes separator	
	Material	PVC	PTFE
	Colour	Red	White
	Electrode diameter	5 mm	

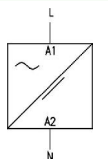
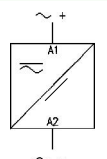
		KNCA / KNPA	
			
Supply voltage	Galvani isolation	Yes	Yes
	Frequency	50 / 60 Hz	-
	Operating margins	±10..-15%	-
	Positive	-	Terminal A1
	Protected polarity	-	Yes

Microlectra bv.
Augustapolder 12.
2992 SR Barendrecht
The Netherlands
www.microlectra.com
info@microlectra.nl